

TEST REPORT

Report No.: BCTC2111806280E

Applicant: Dewolf Technologies, Inc. (DBA Protectli)

Product Name: Small Form Factor Computer

Model/Type reference: VP2410

Tested Date: 2021-12-08 to 2021-12-14

Issued Date: 2021-12-29

Shenzhen  BCTC Testing Co., Ltd.



Product Name: Small Form Factor Computer
Trademark: N/A
Model/Type reference: VP2410
FW1, FW2, FW2B, FW4A, FW4B, FW6A, FW6B, FW6C, FW6D, FW6E, VP2XXX,
VP3XXX, VP4XXX, VP5XXX, VP6XXX
Prepared For: Dewolf Technologies, Inc. (DBA Protectli)
Address: 1315 Hotspring Way, STE 107Vista, CA 92081 USA
Manufacturer: Dewolf Technologies, Inc. (DBA Protectli)
Address: 1315 Hotspring Way, STE 107Vista, CA 92081 USA
Prepared By: Shenzhen BCTC Testing Co., Ltd.
Address: 1-2/F., Building B, Pengzhou Industrial Park, No.158, Fuyuan 1st Road, Tangwei,
Fuhai Subdistrict, Bao'an District, Shenzhen, Guangdong, China
Sample Received Date: 2021-12-08
Sample tested Date: 2021-12-08 to 2021-12-14
Issue Date: 2021-12-29
Report No.: BCTC2111806280E
Test Standards: EN 55032:2015+A1:2020, EN 55035:2017+A11:2020
EN IEC 61000-3-2:2019, EN 61000-3-3:2013+A1:2019
Test Results: PASS

Tested by:



Sheldon Sun/ Project Handler

Approved by:



Zero Zhou/Reviewer

The test report is effective only with both signature and specialized stamp. This result(s) shown in this report refer only to the sample(s) tested. Without written approval of Shenzhen BCTC Testing Co., Ltd, this report can't be reproduced except in full. The tested sample(s) and the sample information are provided by the client.

Table Of Content

	Page
Test Report Declaration	
1. Version	5
2. Test Summary	6
3. Measurement Uncertainty	7
4. Product Information And Test Setup	8
4.1 Product Information.....	8
4.2 Test Setup Configuration	8
4.3 Support Equipment	8
4.4 Test Mode	9
5. Test Facility And Test Instrument Used.....	10
5.1 Test Facility.....	10
5.2 Test Instrument Used.....	10
6. Conducted Emissions.....	12
6.1 Block Diagram Of Test Setup.....	12
6.2 Limit	12
6.3 Test procedure	13
6.4 Test Result.....	14
7. Radiated Emissions Test.....	17
7.1 Block Diagram Of Test Setup.....	17
7.2 Limits.....	17
7.3 Test Procedure	17
7.4 Test Results	18
8. Voltage fluctuations & flicker(F).....	20
8.1 Block Diagram of Test Setup	20
8.2 Limit	20
8.3 Test Procedure	20
8.4 Test Results	21
9. Immunity Test Of General The Performance Criteria	22
10. Electrostatic Discharge (ESD).....	23
10.1 Test Specification.....	23
10.2 Block Diagram of Test Setup	23
10.3 Test Procedure	23
10.4 Test Results	24
11. Continuous RF Electromagnetic Field Disturbances (RS).....	25
11.1 Test Specification.....	25
11.2 Block Diagram of Test Setup	25
11.3 Test Procedure	26
11.4 Test Results	26
12. Electrical Fast Transients/Burst (EFT).....	27
12.1 Test Specification.....	27
12.2 Block Diagram of EUT Test Setup	27
12.3 Test Procedure	27
12.4 Test Results	27
13. Surges Immunity Test	28
13.1 Test Specification.....	28
13.2 Block Diagram of EUT Test Setup	28

13.3	Test Procedure	28
13.4	Test Result.....	28
14.	Continuous Induced RF Disturbances (CS)	29
14.1	Test Specification.....	29
14.2	Block Diagram of EUT Test Setup	29
14.3	Test Procedure	29
14.4	Test Result.....	29
15.	Voltage Dips And Interruptions (DIPS)	30
15.1	Test Specification.....	30
15.2	Block Diagram of EUT Test Setup	30
15.3	Test Procedure	30
15.4	Test Result.....	30
16.	EUT Photographs.....	31
17.	EUT Test Setup Photographs.....	39

(Note: N/A Means Not Applicable)

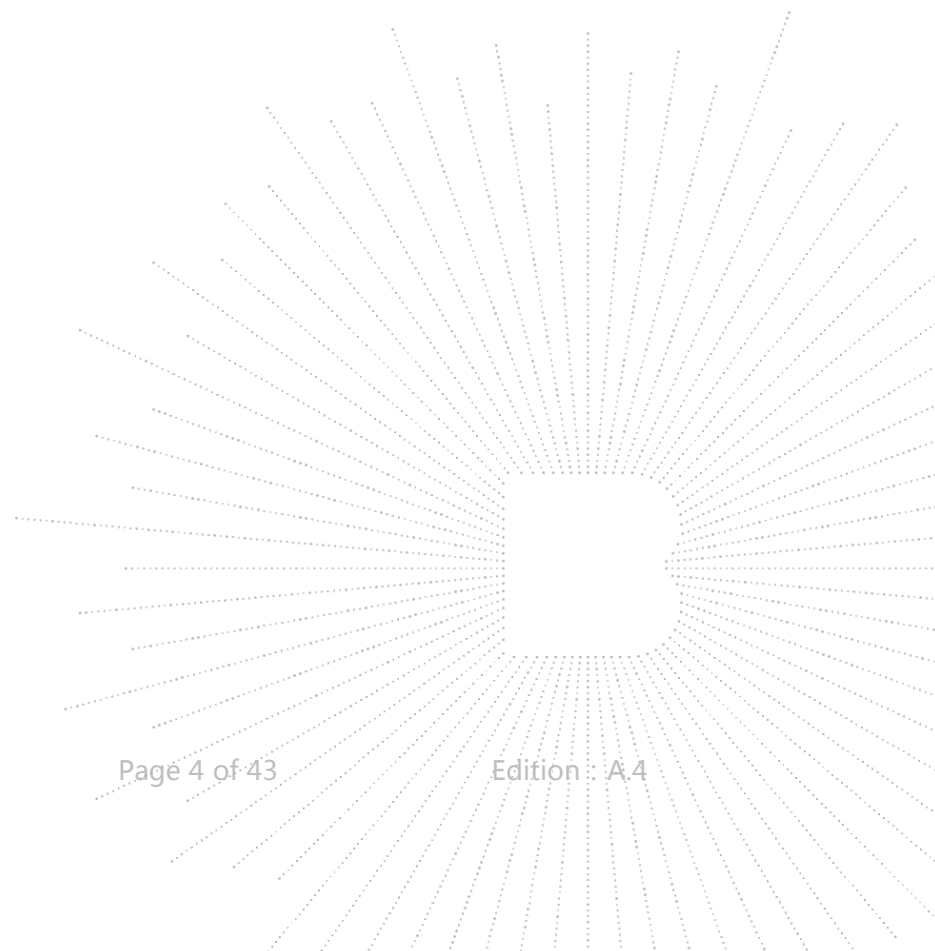

1. Version

ReportNo.	Issue Date	Description	Approved
BCTC2111806280E	2021-12-29	Original	Valid

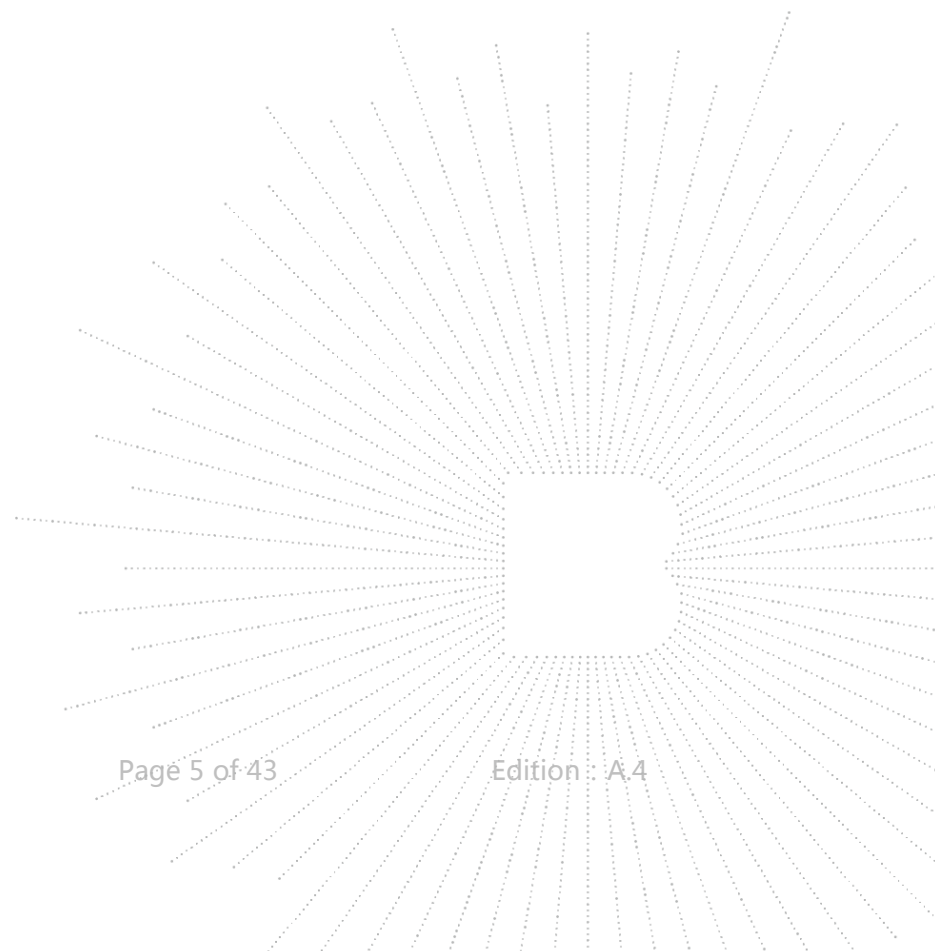

2. Test Summary

The Product has been tested according to the following specifications:

EMISSION		
Standard	Test Item	Test result
EN 55032	Conducted emissions from the AC mains power ports	Pass
EN 55032	Asymmetric mode conducted emissions	Pass
EN 55032	Conducted differential voltage emissions	N/A ¹
EN 55032	Radiated emissions	Pass
EN 61000-3-3	Voltage fluctuations & flicker(F)	Pass

IMMUNITY		
Standard	Test Item	Test result
IEC 61000-4-2	Electrostatic discharge (ESD)	Pass
IEC 61000-4-3	Continuous RF electromagnetic field disturbances(RS)	Pass
IEC 61000-4-4	Electrical fast transients/burst (EFT)	Pass
IEC 61000-4-5	Surges	Pass
IEC 61000-4-6	Continuous induced RF disturbances (CS)	Pass
IEC 61000-4-6	Broadband impulse noise disturbances, repetitive	N/A ²
IEC 61000-4-6	Broadband impulse noise disturbances, isolated	N/A ²
IEC 61000-4-8	Power frequency magnetic field (PFMF)	N/A ³
IEC 61000-4-11	Voltage dips and interruptions (DIPS)	Pass

Remark:

1. The Product has no antenna port.
2. Applicable only to CPE xDSL ports.
3. The Product doesn't contain any device susceptible to magnetic fields.

3. Measurement Uncertainty

Where relevant, the following measurement uncertainty levels have been estimated for tests performed on the Product as specified in CISPR 16-4-2. This uncertainty represents an expanded uncertainty expressed at approximately the 95% confidence level using a coverage factor of $k=2$.

Test item	Value (dB)
Conducted Emission (150kHz-30MHz)	3.20
Radiated Emission(30MHz~1GHz)	4.80

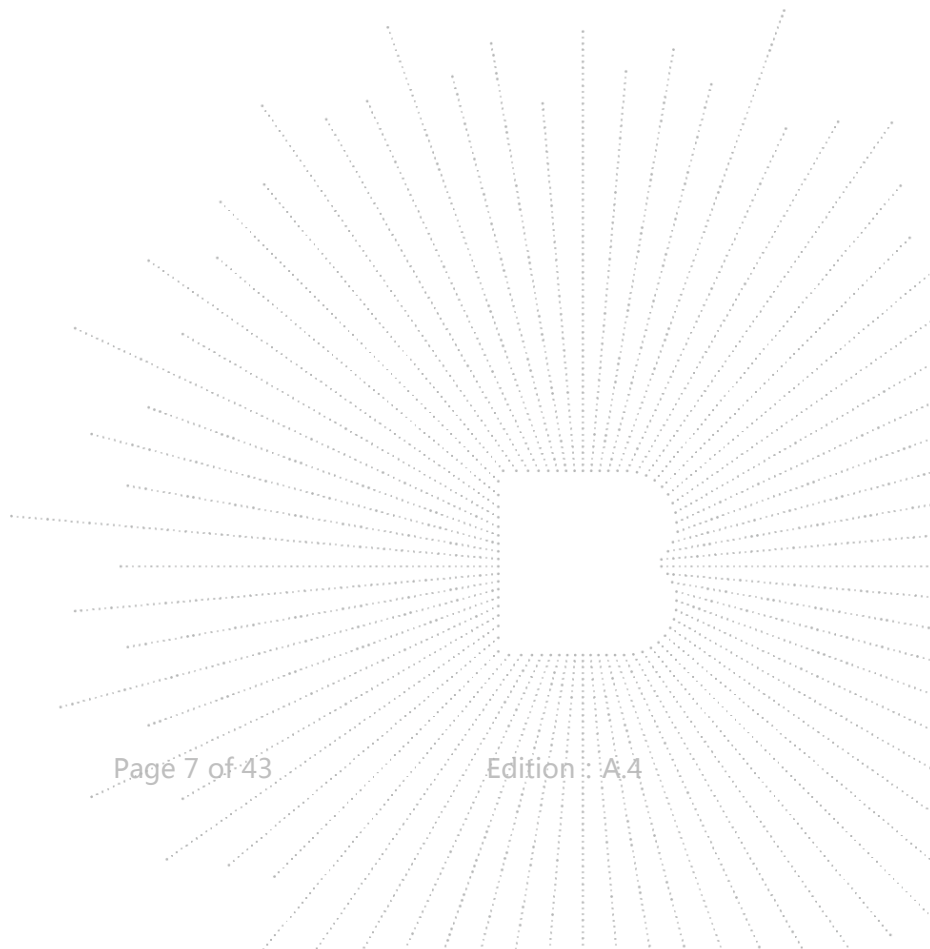

4. Product Information And Test Setup

4.1 Product Information

Ratings: DC 12V From Adapter
Adapter: MODEL:KPL-040F-VI
 INPUT:100-240V~50/60Hz
 OUTPUT:DC 12V 3.33A 40.0W

Model differences: All models are identical except for the appearance color, the test model is VP2410 and the test results are applicable to other tests.

The highest frequency of the internal sources of the EUT is (less than 108)MHz:
 less than 108 MHz, the measurement shall only be made up to 1 GHz.
 between 108 MHz and 500 MHz, the measurement shall only be made up to 2 GHz.
 between 500 MHz and 1 GHz, the measurement shall only be made up to 5 GHz.
 above 1 GHz, the measurement shall be made up to 5 times the highest frequency or 6 GHz, whichever is less.

4.2 Test Setup Configuration

See test photographs attached in EUT TEST SETUP PHOTOGRAPHS for the actual connections between Product and support equipment.

4.3 Support Equipment

No.	Device Type	Brand	Model	Series No.	Data Cable	Power Cord
1.	Display	AOC	T3250MDK	---	---	---

Notes:

- All the equipment/cables were placed in the worst-case configuration to maximize the emission during the test.
- Grounding was established in accordance with the manufacturer's requirements and conditions for the intended use.

4.4 Test Mode

Test item	Test Mode	Test Voltage
Conducted emissions from the AC mains power ports (150KHz-30MHz) Class B	Working 1	AC 230V/50Hz
	Working 2	AC 230V/50Hz*
Asymmetric mode conducted emissions(150KHz-30MHz)Class B	Working 1	AC 230V/50Hz
	Working 2	AC 230V/50Hz*
Radiated emissions(30MHz-1GHz)Class B	Working 1	AC 230V/50Hz*
	Working 2	AC 230V/50Hz
Voltage fluctuations & flicker(F)	Working 1	AC 230V/50Hz*
	Working 2	AC 230V/50Hz
Electrostatic discharge (ESD) <input checked="" type="checkbox"/> Air Discharge: $\pm 2,4,8$ kV <input checked="" type="checkbox"/> Contact Discharge: $\pm 2,4$ kV <input checked="" type="checkbox"/> HCP & VCP: $\pm 2,4$ kV	Working 1	AC 230V/50Hz
	Working 2	AC 230V/50Hz
Continuous RF electromagnetic field disturbances(RS) 80MHz-1000MHz, 1800MHz, 2600MHz,3500MHz,5000MHz 3V/m,80% AM Front, Rear, Left, Right H/V	Working 1	AC 230V/50Hz
	Working 2	AC 230V/50Hz
Electrical fast transients/burst (EFT) <input checked="" type="checkbox"/> 1kV AC(Input) <input type="checkbox"/> 0.5kV DC(Input) <input type="checkbox"/> 0.5kV signal,Telec,control	Working 1	AC 230V/50Hz
	Working 2	AC 230V/50Hz
Surges <input checked="" type="checkbox"/> 1kV Line-Line, <input type="checkbox"/> 2kV Line-PE, N-PE <input type="checkbox"/> 0.5kVDC(Input) <input type="checkbox"/> 1KV, <input type="checkbox"/> 4KV signal,Telec,control Line-Line:90°+1kV,270°-1kV Line-PE:90°+2kV,270°-2kV N-PE:90°-2kV,270°+2kV	Working 1	AC 230V/50Hz
	Working 2	AC 230V/50Hz
Continuous induced RF disturbances (CS) 0.15MHz to 80MHz 3V <input checked="" type="checkbox"/> AC(Input) <input type="checkbox"/> DC(Input) <input type="checkbox"/> signal,control	Working 1	AC 230V/50Hz
	Working 2	AC 230V/50Hz
Voltage dips and interruptions (DIPS) Less 5% 0.5P 10msB 70% 25P 500msB Voltage Interruptions less5% 250P 5000msC	Working 1	AC 230V/50Hz
	Working 2	AC 230V/50Hz
All test mode were tested and passed, only Conducted Emissions, Radiated Emissions and Voltage fluctuations & flickers shows (*) is the worst case mode which were recorded in this report.		
Working 1:HDMI+ mouse + keyboard + burner software +T-C usb flash drive + Ping IP		
Working 2:DP+ mouse + keyboard + burner software +T-C U disk +ping IP		

5. Test Facility And Test Instrument Used

5.1 Test Facility

All measurement facilities used to collect the measurement data are located at Shenzhen BCTC Testing Co., Ltd. Address:1-2/F., Building B, Pengzhou Industrial Park, No.158, Fuyuan 1st Road, Tangwei, Fuhai Subdistrict, Bao'an District, Shenzhen, Guangdong, China. The site and apparatus are constructed in conformance with the requirements of ANSI C63.4 and CISPR 16-1-1 other equivalent standards.

5.2 Test Instrument Used

Conducted Emissions Test					
Equipment	Manufacturer	Model#	Serial#	Last Cal.	Next Cal.
Receiver	R&S	ESR3	102075	May 28, 2021	May 27, 2022
LISN	R&S	ENV216	101375	May 28, 2021	May 27, 2022
ISN	HPX	ISN T800	S1509001	May 28, 2021	May 27, 2022
Software	Frad	EZ-EMC	EMC-CON 3A1	\	\
Attenuator	\	10dB DC-6GHz	1650	May 28, 2021	May 27, 2022

Radiated Emissions Test (966 Chamber#01)					
Equipment	Manufacturer	Model#	Serial#	Last Cal.	Next Cal.
966 chamber	ChengYu	966 Room	966	Jun. 06. 2020	Jun. 05, 2023
Receiver	R&S	ESRP	101154	May 28, 2021	May 27, 2022
Receiver	R&S	ESR3	102075	May 28, 2021	May 27, 2022
Amplifier	SKET	LAPA_01G18 G-45dB	\	May 28, 2021	May 27, 2022
Amplifier	Schwarzbeck	BBV9744	9744-0037	May 28, 2021	May 27, 2022
TRILOG Broadband Antenna	schwarzbeck	VULB9163	942	Jun. 01, 2021	May 31, 2022
Horn Antenna	schwarzbeck	BBHA9120D	1541	Jun. 02, 2021	Jun. 01, 2022
Software	Frad	EZ-EMC	FA-03A2 RE	\	\

Harmonic / Flicker Test					
Equipment	Manufacturer	Model#	Serial#	Last Cal.	Next Cal.
Harmonic & Flicker Tester	LAPLAEC	AC2000A	439263	May 31, 2021	May 30, 2022
AC Power Supply	KIKUSUI	PCR4000M	UK001879	May 28, 2021	May 27, 2022
Software	HTEC	\	\	\	\

Electrostatic Discharge Test					
Equipment	Manufacturer	Model#	Serial#	Last Cal.	Next Cal.
ESD Tester	KIKUSUI	KES4201A	UH002321	May 31, 2021	May 30, 2022

Continuous RF Electromagnetic Field Disturbances Test					
Equipment	Manufacturer	Model#	Serial#	Last Cal.	Next Cal.
Power meter	Keysight	E4419	\	May 28, 2021	May 27, 2022
Power sensor	Keysight	E9300A	\	May 28, 2021	May 27, 2022
Power sensor	Keysight	E9300A	\	May 28, 2021	May 27, 2022
Amplifier	SKET	HAP_801000 -250W	\	May 28, 2021	May 27, 2022
Amplifier	SKET	HAP_0103-7 5W	\	May 28, 2021	May 27, 2022
Amplifier	SKET	HAP_0306-5 0W	\	May 28, 2021	May 27, 2022
Stacked double Log.-Per. Antenna	Schwarzbeck	STLP 9129	\	\	\
Field Probe	Narda	EP-601	\	Jun. 29, 2021	Jun. 28, 2022
Signal Generator	Agilent	N5181A	MY50143748	Jun. 29, 2021	Jun. 28, 2022
Software	SKET	EMC-S	1.2.0.18	\	\

EFT And Voltage Dips And Interruptions Test					
Equipment	Manufacturer	Model#	Serial#	Last Cal.	Next Cal.
Compact Generator	TRANSIENT	TRA2000	646	Jun. 29, 2021	Jun. 28, 2022
Coupling Clamp	PARTNER	CN-EFT1000	CN-EFT100 0-1624	May 28, 2021	May 27, 2022

Surge Test					
Equipment	Manufacturer	Model#	Serial#	Last Cal.	Next Cal.
Lightning decoupling network	Prima	DATA-CDN-8B	PR210955324	Nov. 05, 2021	Nov. 04, 2022
Signal line lightning strike generator	Prima	SUG10/700G	PR151151067	Jun. 03, 2021	Jun. 02,2022

Continuous Induced RF Disturbances Test					
Equipment	Manufacturer	Model#	Serial#	Last Cal.	Next Cal.
C/S Test System	SCHLODER	CDG-6000-7 5	126B1405/201 6	May 28, 2021	May 27, 2022
Attenuator	SCHLODER	6DB DC-1G	HA1630	May 28, 2021	May 27, 2022
CDN	SCHLODER	CDN M2+M3	A2210389/201 6	May 28, 2021	May 27, 2022
Injection Clamp	SCHLOBER	EMCL-20	132A1272/201 6	May 28, 2021	May 27, 2022
Software	HUBERT	HUBERTEN 61000-4-6	1.4.1.0	\	\

6. Conducted Emissions

6.1 Block Diagram Of Test Setup

For mains ports:

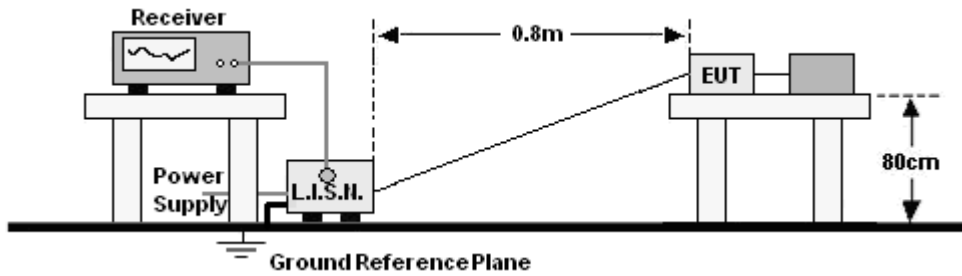

For asymmetric mode ports:

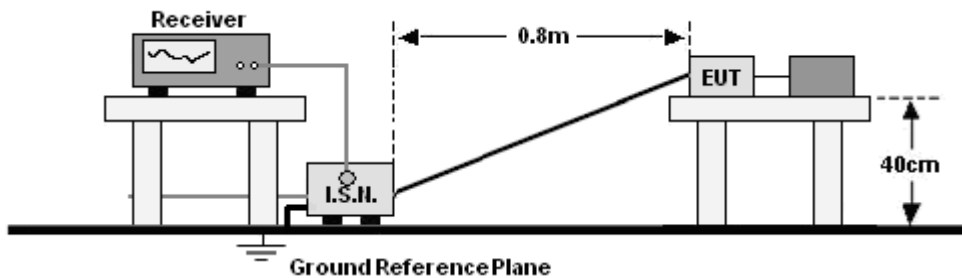

6.2 Limit

Limits for Conducted emissions at the mains ports of Class B MME

Frequency range(MHz)	Limits dB(μ V)	
	Quasi-peak	Average
0,15 to 0,50	66 to 56*	56 to 46*
0,50 to 5	56	46
5 to 30	60	50

Notes: 1. *Decreasing linearly with logarithm of frequency.
2. The lower limit shall apply at the transition frequencies.

Limits for asymmetric mode conducted emissions of Class B MME

Frequency range(MHz)	Voltage LimitsdB(μ V)		Current LimitsdB(μ A)	
	Quasi-peak	Average	Quasi-peak	Average
0,15 to 0,50	84-74	74-64	40-30	30-20
0,50 to 30	74	64	30	20

Notes: *Decreasing linearly with logarithm of frequency.

6.3 Test procedure

For mains ports:

- a. The Product was placed on a nonconductive table 0.8 m above the horizontal ground reference plane, and 0.4 m from the vertical ground reference plane, and connected to the main through Line Impedance Stability Network (L.I.S.N).
- b. The RBW of the receiver was set at 9 kHz in 150 kHz ~30MHz with Peak and AVG detector in Max Hold mode. Run the receiver's pre-scan to record the maximum disturbance generated from Product in all power lines in the full band.
- c. For each frequency whose maximum record was higher or close to limit, measure its QP and AVG values and record.

For asymmetric mode ports:

- a. The Product was placed on a non-conductive table 0.8 m above the horizontal ground reference plane, and 0.4 m from the vertical ground reference plane, and connected to the associated port through current probe.
- b. The RBW of the receiver was set at 9 kHz in 150 kHz ~ 30MHz with Peak and AVG detector in Max Hold mode. Run the receiver's pre-scan to record the maximum disturbance generated from Product in all power lines in the full band.
- c. For each frequency whose maximum record was higher or close to limit, measure its QP and AVG values and record.

6.4 Test Result

Temperature:	26°C	Relative Humidity:	54%
Pressure:	101kPa	Phase :	Line
Test Voltage :	AC 230V/50Hz	Test Mode:	The worst data

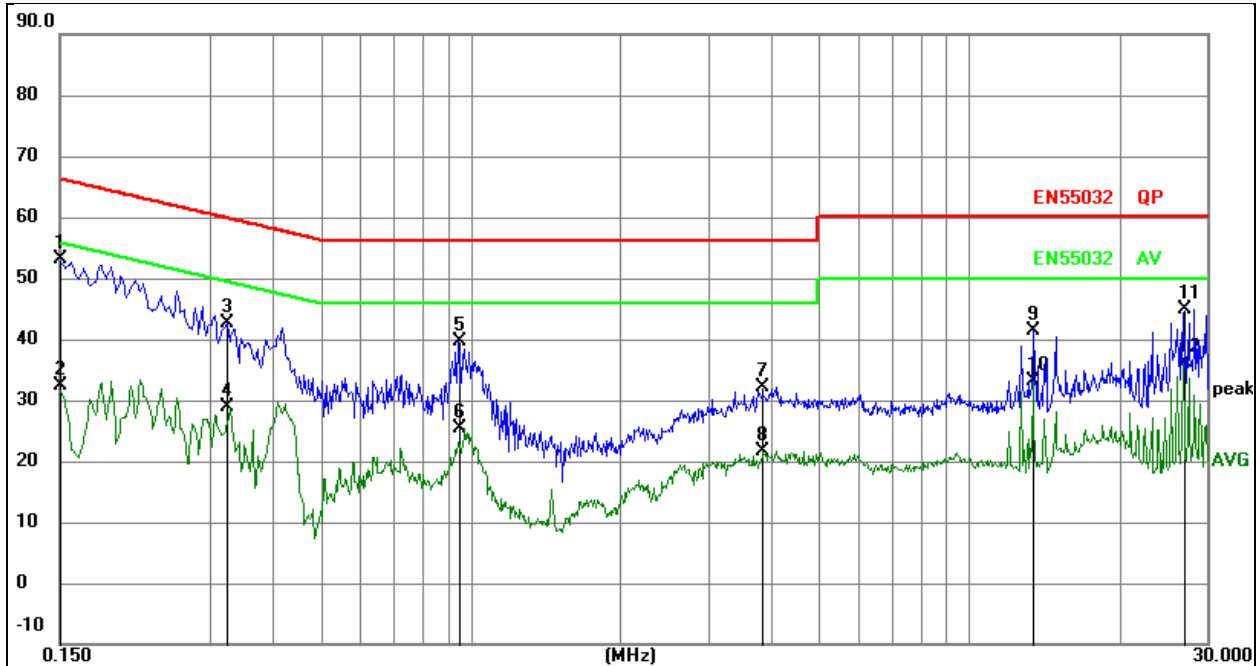

Remark:

1. All readings are Quasi-Peak and Average values.
2. Factor = Insertion Loss + Cable Loss.

No.	Mk.	Freq. MHz	Reading Level	Correct Factor dB	Measure- ment dBuV	Limit dBuV	Over dB	Detector
1	*	0.1500	33.44	19.61	53.05	66.00	-12.95	QP
2		0.1500	12.69	19.61	32.30	56.00	-23.70	AVG
3		0.3251	22.91	19.61	42.52	59.58	-17.06	QP
4		0.3251	9.30	19.61	28.91	49.58	-20.67	AVG
5		0.9431	20.09	19.62	39.71	56.00	-16.29	QP
6		0.9431	5.72	19.62	25.34	46.00	-20.66	AVG
7		3.8603	12.43	19.68	32.11	56.00	-23.89	QP
8		3.8603	2.07	19.68	21.75	46.00	-24.25	AVG
9		13.4080	21.55	19.79	41.34	60.00	-18.66	QP
10		13.4080	13.43	19.79	33.22	50.00	-16.78	AVG
11		26.8411	25.08	19.74	44.82	60.00	-15.18	QP
12		26.8411	16.28	19.74	36.02	50.00	-13.98	AVG

Temperature:	26°C	Relative Humidity:	54%
Pressure:	101kPa	Phase :	Neutral
Test Voltage :	AC 230V/50Hz	Test Mode:	The worst data

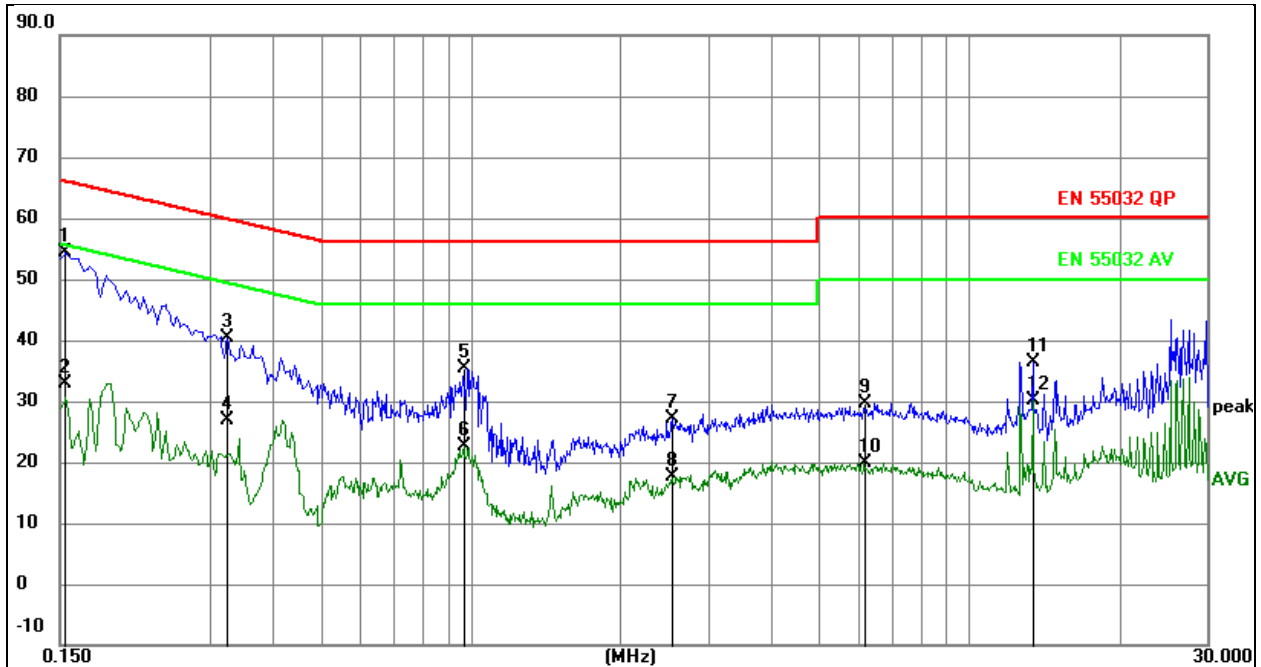
Remark:

1. All readings are Quasi-Peak and Average values.
2. Factor = Insertion Loss + Cable Loss.

No.	Mk.	Freq. MHz	Reading Level dB	Correct Factor dB	Measurement dBuV	Limit dBuV	Over dB	Detector
1	*	0.1539	34.66	19.61	54.27	65.79	-11.52	QP
2		0.1539	13.24	19.61	32.85	55.79	-22.94	AVG
3		0.3251	20.88	19.61	40.49	59.58	-19.09	QP
4		0.3251	7.33	19.61	26.94	49.58	-22.64	AVG
5		0.9684	15.79	19.63	35.42	56.00	-20.58	QP
6		0.9684	3.08	19.63	22.71	46.00	-23.29	AVG
7		2.5400	7.50	19.64	27.14	56.00	-28.86	QP
8		2.5400	-2.02	19.64	17.62	46.00	-28.38	AVG
9		6.1534	9.97	19.73	29.70	60.00	-30.30	QP
10		6.1534	0.12	19.73	19.85	50.00	-30.15	AVG
11		13.4080	16.65	19.79	36.44	60.00	-23.56	QP
12		13.4080	10.40	19.79	30.19	50.00	-19.81	AVG

Temperature:	26°C	Relative Humidity:	54%
Pressure:	101kPa	Phase :	TELE
Test Voltage :	AC 230V/50Hz	Test Mode:	The worst data

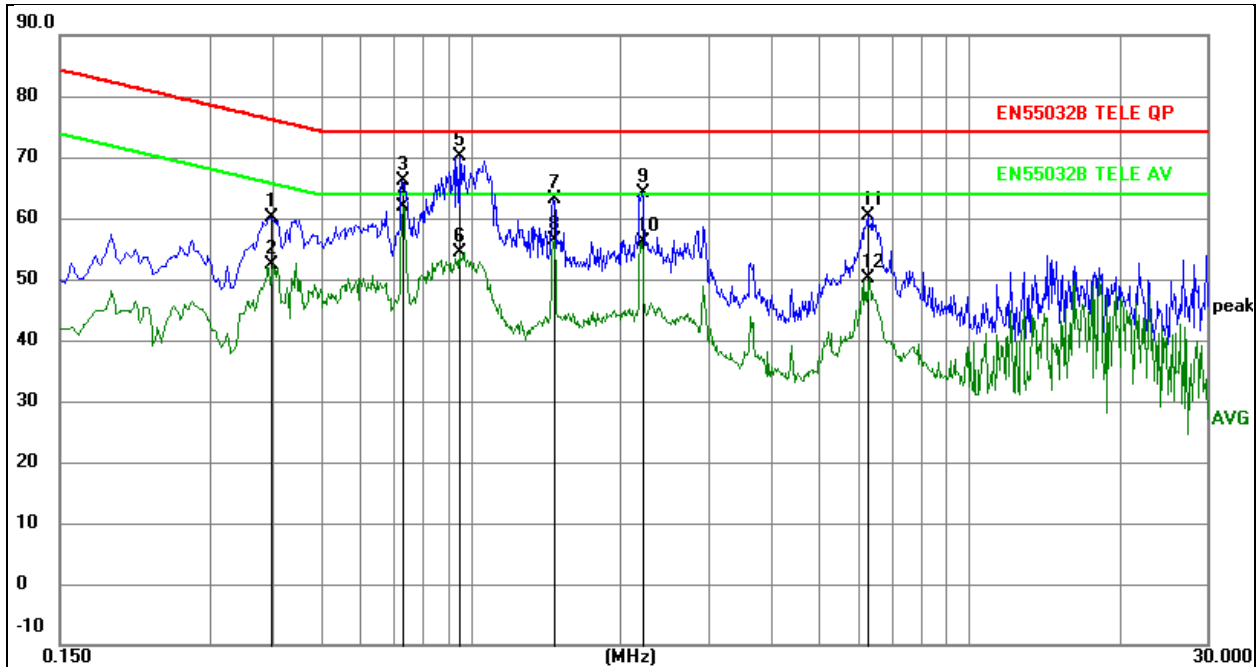
Remark:

1. All readings are Quasi-Peak and Average values.
2. Factor = Insertion Loss + Cable Loss.

No.	Mk.	Freq. MHz	Reading Level	Correct Factor dB	Measure- ment dBuV	Limit dBuV	Over dB	Detector
1		0.3975	40.61	19.62	60.23	75.91	-15.68	QP
2		0.3975	32.68	19.62	52.30	65.91	-13.61	AVG
3		0.7304	46.49	19.62	66.11	74.00	-7.89	QP
4	*	0.7304	42.22	19.62	61.84	64.00	-2.16	AVG
5		0.9507	50.43	19.62	70.05	74.00	-3.95	QP
6		0.9507	34.84	19.62	54.46	64.00	-9.54	AVG
7		1.4682	43.56	19.63	63.19	74.00	-10.81	QP
8		1.4682	36.85	19.63	56.48	64.00	-7.52	AVG
9		2.2109	44.56	19.64	64.20	74.00	-9.80	QP
10		2.2109	36.54	19.64	56.18	64.00	-7.82	AVG
11		6.2609	40.54	19.73	60.27	74.00	-13.73	QP
12		6.2609	30.38	19.73	50.11	64.00	-13.89	AVG

7. Radiated Emissions Test

7.1 Block Diagram Of Test Setup

30MHz ~ 1GHz:

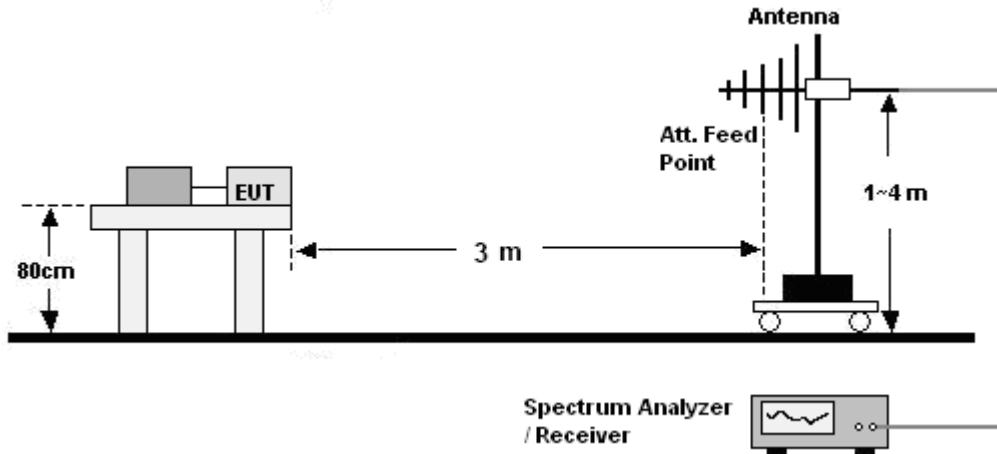

7.2 Limits

Limits for radiated disturbance of Class B MME

Frequency (MHz)	Quasi-peak limits at 3m dB(μ V/m)
30-230	40
230-1000	47

7.3 Test Procedure

30MHz ~ 1GHz:

- The Product was placed on the nonconductive turntable 0.8 m above the ground in a semi anechoic chamber.
- Set the spectrum analyzer/receiver in Peak detector, Max Hold mode, and 120 kHz RBW. Record the maximum field strength of all the pre-scan process in the full band when the antenna is varied between 1~4 m in both horizontal and vertical, and the turntable is rotated from 0 to 360 degrees.
- For each frequency whose maximum record was higher or close to limit, measure its QP value: vary the antenna's height and rotate the turntable from 0 to 360 degrees to find the height and degree where Product radiated the maximum emission, then set the test frequency analyzer/receiver to QP Detector and specified bandwidth with Maximum Hold Mode, and record the maximum value.

7.4 Test Results

Temperature:	26°C	Relative Humidity:	54%
Pressure:	101KPa	Phase :	Horizontal
Test Voltage :	AC 230V/50Hz	Test Mode:	The worst data

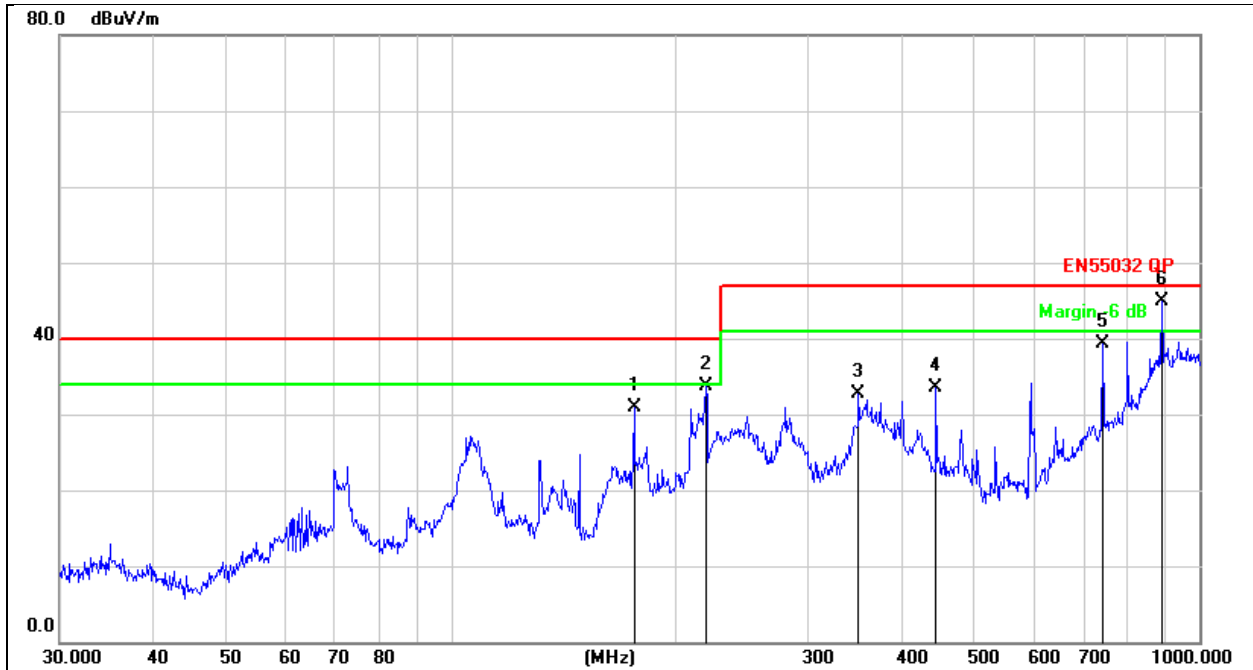

Remark:
Factor = Antenna Factor + Cable Loss – Pre-amplifier.

No.	Mk.	Freq.	Reading Level	Correct Factor	Measurement	Limit	Over	Detector
		MHz	dBuV	dB	dBuV/m	dB/m	dB	
1		175.6516	48.35	-17.42	30.93	40.00	-9.07	QP
2		219.0753	48.76	-15.14	33.62	40.00	-6.38	QP
3		350.4768	44.90	-12.29	32.61	47.00	-14.39	QP
4		444.8514	43.12	-9.71	33.41	47.00	-13.59	QP
5		742.2587	42.38	-2.99	39.39	47.00	-7.61	QP
6	*	890.7278	44.73	0.23	44.96	47.00	-2.04	QP

Temperature:	26°C	Relative Humidity:	54%
Pressure:	101KPa	Phase :	Vertical
Test Voltage :	AC 230V/50Hz	Test Mode:	The worst data

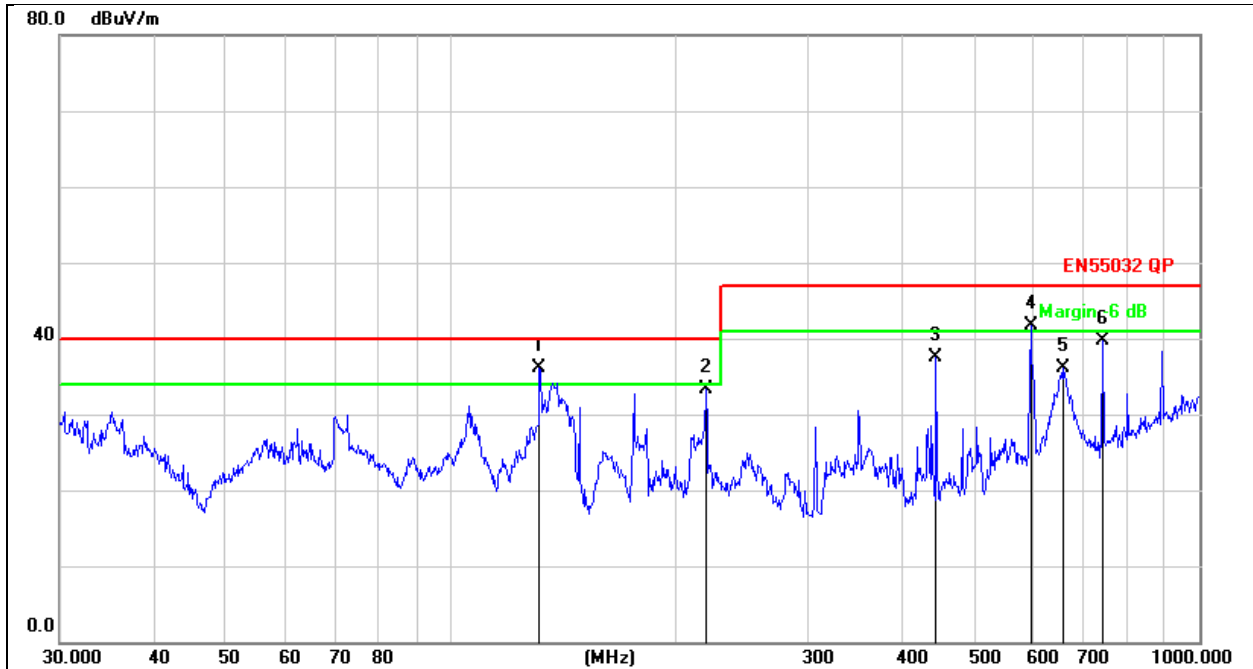

Remark:
Factor = Antenna Factor + Cable Loss – Pre-amplifier.

No.	Mk.	Freq. MHz	Reading Level dBuV	Correct Factor dB	Measure- ment dBuV/m	Limit dB/m	Over dB	Detector
1	*	131.2965	54.28	-18.23	36.05	40.00	-3.95	QP
2		219.0753	48.35	-15.14	33.21	40.00	-6.79	QP
3		444.8514	47.17	-9.71	37.46	47.00	-9.54	QP
4	!	595.1329	47.74	-6.13	41.61	47.00	-5.39	QP
5		656.5300	40.85	-4.65	36.20	47.00	-10.80	QP
6		742.2587	42.69	-2.99	39.70	47.00	-7.30	QP

8. Voltage fluctuations & flicker(F)

8.1 Block Diagram of Test Setup

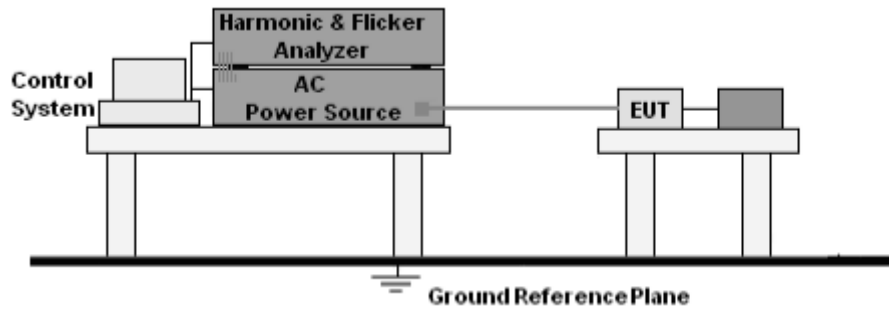

8.2 Limit

EN 61000-3-3:2013+A1:2019 Clause 5.

8.3 Test Procedure

- The Product was placed on the top of a non-conductive table above the ground and operated to produce the most unfavorable sequence of voltage changes under normal operating conditions.
- During the flick test, the measure time shall include that part of whole operation cycle in which the Product produce the most unfavorable sequence of voltage changes. The observation period for short-term flicker indicator is 10 minutes and the observation period for long-term flicker indicator is 2 hours.

9. Immunity Test Of General The Performance Criteria

Product Standard	EN 55035:2017+A11:2020 clause 5
CRITERION A	<p>The equipment shall continue to operate as intended without operator intervention. No degradation of performance, loss of function or change of operating state is allowed below a performance level specified by the manufacturer when the equipment is used as intended. The performance level may be replaced by a permissible loss of performance. If the minimum performance level or the permissible performance loss is not specified by the manufacturer, then either of these may be derived from the product description and documentation, and by what the user may reasonably expect from the equipment if used as intended.</p>
CRITERION B	<p>During the application of the disturbance, degradation of performance is allowed. However, no unintended change of actual operating state or stored data is allowed to persist after the test.</p> <p>After the test, the equipment shall continue to operate as intended without operator intervention; no degradation of performance or loss of function is allowed, below a performance level specified by the manufacturer, when the equipment is used as intended. The performance level may be replaced by a permissible loss of performance.</p> <p>If the minimum performance level (or the permissible performance loss), or recovery time, is not specified by the manufacturer, then either of these may be derived from the product description and documentation, and by what the user may reasonably expect from the equipment if used as intended.</p>
CRITERION C	<p>Loss of function is allowed, provided the function is self-recoverable, or can be restored by the operation of the controls by the user in accordance with the manufacturer's instructions. A reboot or re-start operation is allowed. Information stored in non-volatile memory, or protected by a battery backup, shall not be lost.</p>

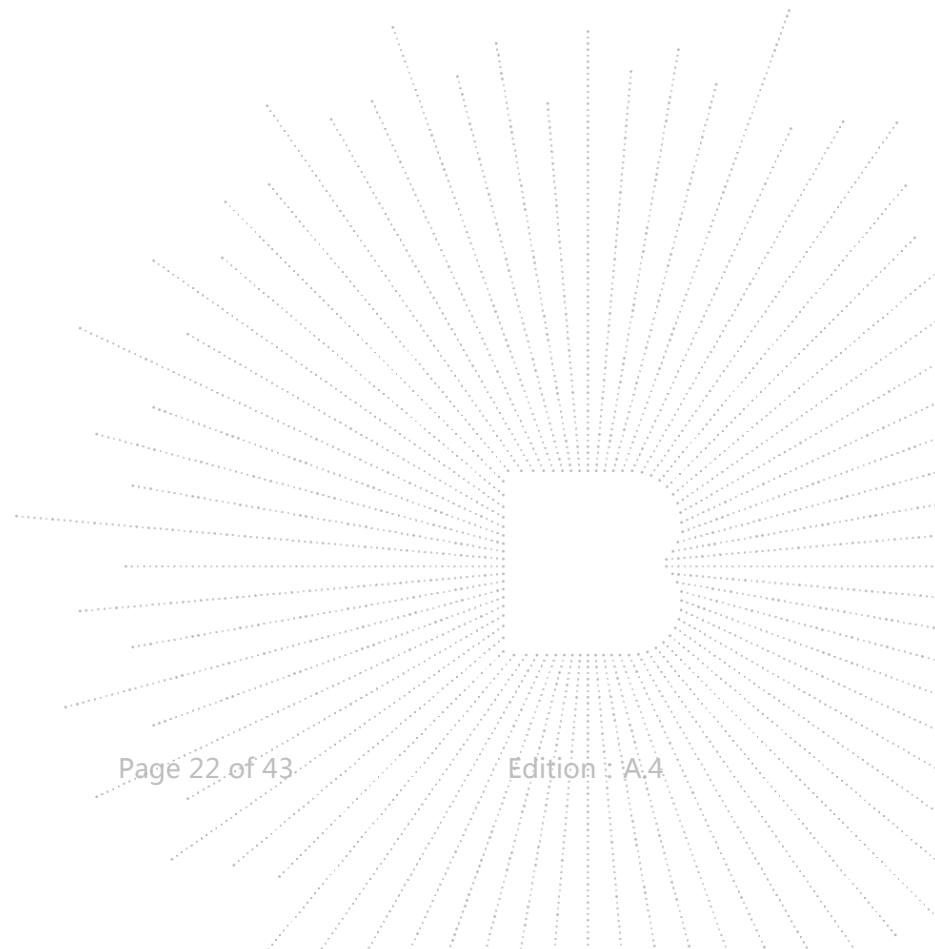

10. Electrostatic Discharge (ESD)

10.1 Test Specification

Test Port	:	Enclosure port
Discharge Impedance	:	330 ohm / 150 pF
Discharge Mode	:	Single Discharge
Discharge Period	:	one second between each discharge

10.2 Block Diagram of Test Setup

For Floor Stand:

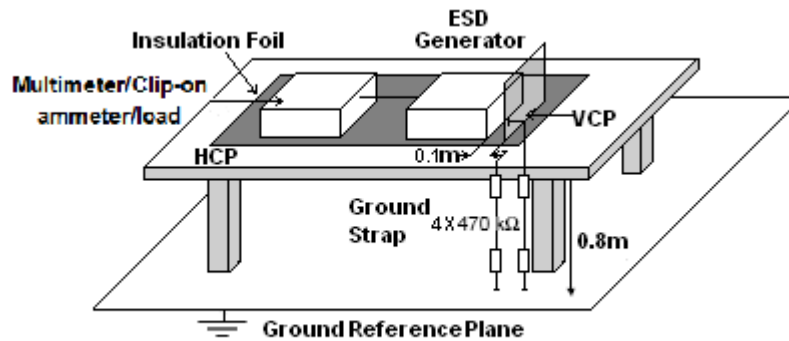

10.3 Test Procedure

- Electrostatic discharges were applied only to those points and surfaces of the Product that are accessible to users during normal operation.
- The test was performed with at least ten single discharges on the pre-selected points in the most sensitive polarity.
- The time interval between two successive single discharges was at least 1 second.
- The ESD generator was held perpendicularly to the surface to which the discharge was applied and the return cable was at least 0.2 meters from the Product.
- Contact discharges were applied to the non-insulating coating, with the pointed tip of the generator penetrating the coating and contacting the conducting substrate.
- Air discharges were applied with the round discharge tip of the discharge electrode approaching the Product as fast as possible (without causing mechanical damage) to touch the Product. After each discharge, the ESD generator was removed from the Product and re-triggered for a new single discharge. The test was repeated until all discharges were complete.
- At least ten single discharges (in the most sensitive polarity) were applied to the center of one vertical edge of the Vertical Coupling Plane in sufficiently different positions that the four faces of the Product were completely illuminated. The VCP (dimensions 0.5m x 0.5m) was placed vertically to and 0.1 meters from the Product.

10.4 Test Results

Temperature:	26°C	Relative Humidity:	54%
Pressure:	101KPa	Test Mode:	Working 1/Working 2
Test Voltage :	AC 230V/50Hz		

Discharge Method	Discharge Position	Voltage (±kV)	Min. No. of Discharge per polarity(Each Point)	Required Level	Performance Criterion
Contact Discharge	Conductive Surfaces	4	10	B	B*
	Indirect Discharge HCP	4	10	B	B*
	Indirect Discharge VCP	4	10	B	B*
Air Discharge	Slots, Apertures, and Insulating Surfaces	8	10	B	B*

Note*:During the test, the product disconnects the charging connection, and the charging connection will be restored automatically after the interference end.

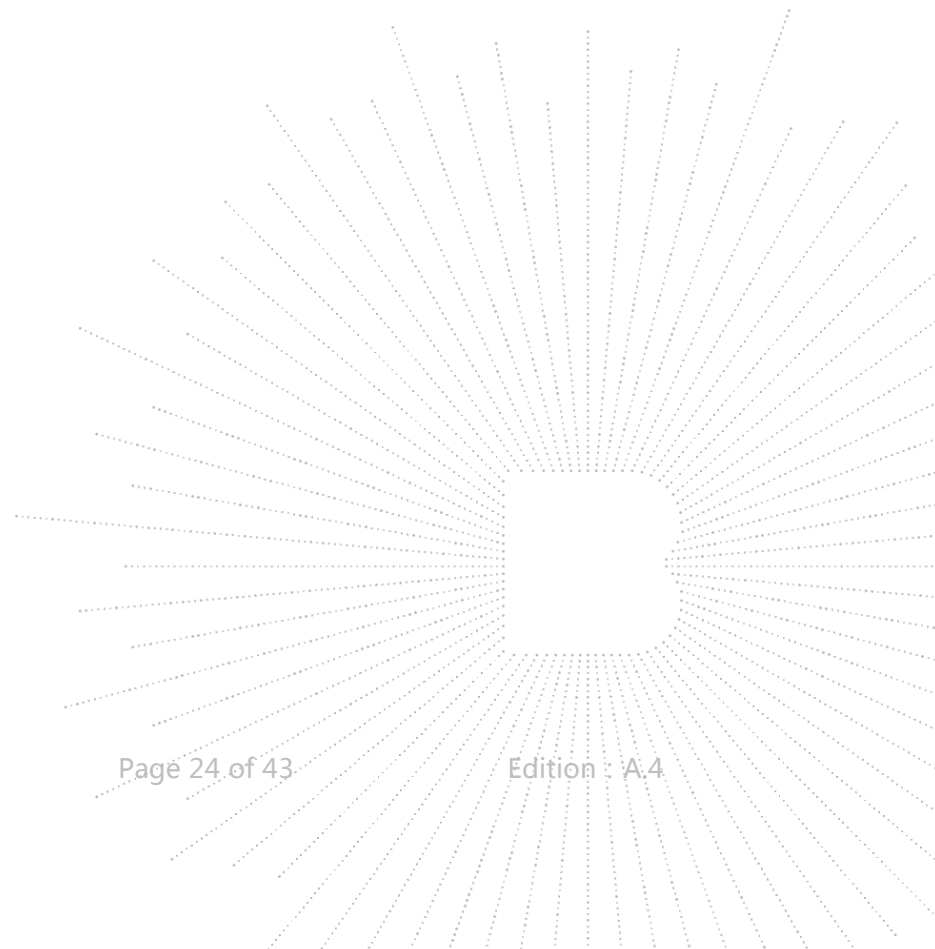

11. Continuous RF Electromagnetic Field Disturbances (RS)

11.1 Test Specification

Test Port	:	Enclosure port
Step Size	:	1%
Modulation	:	1kHz, 80% AM
Dwell Time	:	1 second
Polarization	:	Horizontal & Vertical

11.2 Block Diagram of Test Setup

Below 1GHz:

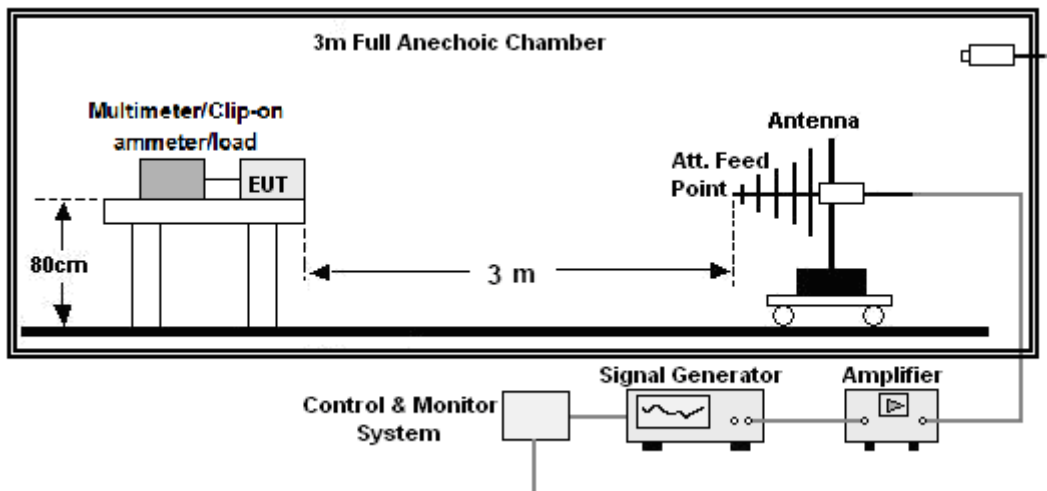

Above 1GHz:

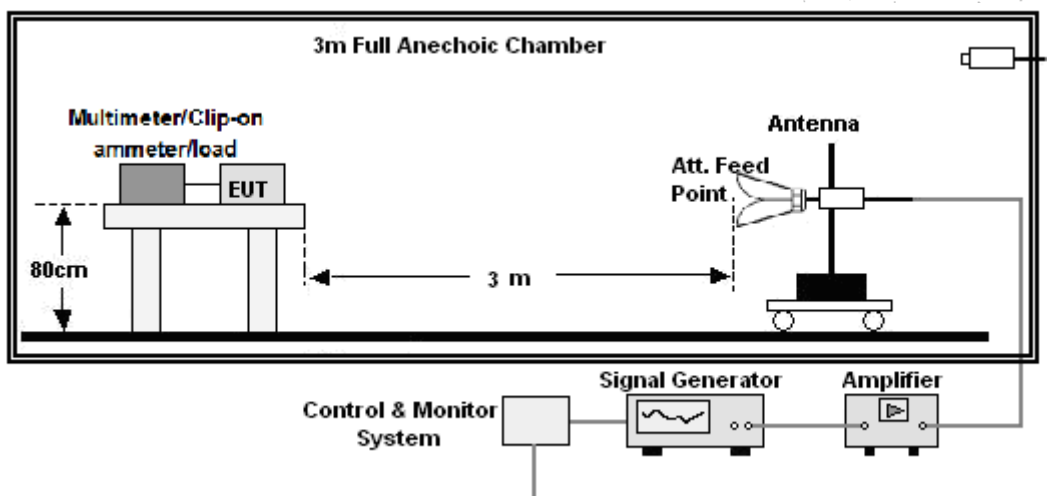

11.3 Test Procedure

- a. The testing was performed in a fully-anechoic chamber. The transmit antenna was located at a distance of 3 meters from the Product.
- b. The frequency range is swept from 80MHz to 1000MHz, 1800MHz, 2600MHz, 3500MHz, 5000MHz, with the signal 80% amplitude modulated with a 1 kHz sine wave, and the step size was 1%.
- c. The dwell time at each frequency shall not be less than the time necessary for the EUT to be exercised and to be able to respond, but should not exceed 5 s at each of the frequencies during the scan.
- d. The test was performed with the Product exposed to both vertically and horizontally polarized fields on each of the four sides.
- e. For Broadcast reception function: Group 2 not apply in this test.

11.4 Test Results

Temperature:	26°C	Relative Humidity:	54%
Pressure:	101KPa	Test Mode:	Working 1/Working 2
Test Voltage :	AC 230V/50Hz		

Frequency	Position	Field Strength(V/m)	Required Level	Performance Criterion
80 - 1000MHz, 1800MHz, 2600MHz, 3500MHz, 5000MHz	Front, Right, Back, Left	3	A	A

12. Electrical Fast Transients/Burst (EFT)

12.1 Test Specification

Test Port	: input ac/dc. power port
Impulse Frequency	: 5 kHz
Impulse Wave-shape	: 5/50 ns
Burst Duration	: 15 ms
Burst Period	: 300 ms
Test Duration	: 2 minutes per polarity

12.2 Block Diagram of EUT Test Setup

For input ac/dc. power port:

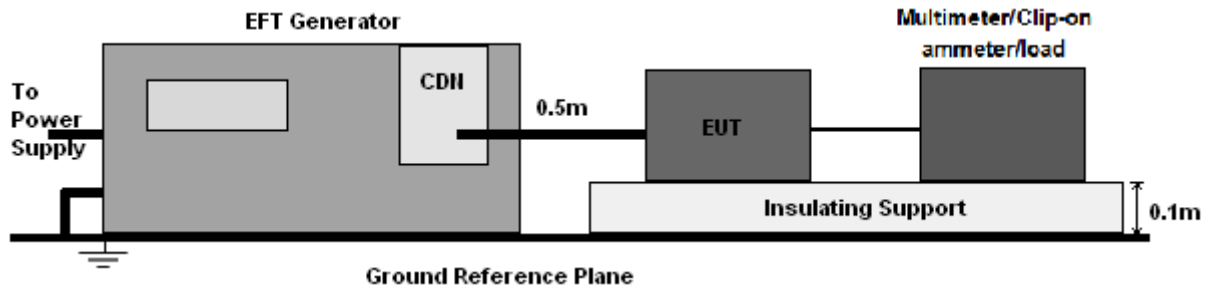

12.3 Test Procedure

- The Product and support units were located on a non-conductive table above ground reference plane.
- A 0.5m-long power cord was attached to Product during the test.

12.4 Test Results

Temperature:	26°C	Relative Humidity:	54%
Pressure:	101KPa	Test Mode:	Working 1/Working 2
Test Voltage :	AC 230V/50Hz		

Coupling	Voltage (kV)	Polarity	Required Level	Performance Criterion
AC Mains L-N	1.0	±	B	A

13. Surges Immunity Test

13.1 Test Specification

Test Port	:	input ac/dc. power port
Wave-Shape	:	Open Circuit Voltage - 1.2 / 50 us Short Circuit Current - 8 / 20 us
Pulse Repetition Rate	:	1 pulse / min.
Phase Angle	:	0° / 90° / 180° / 270°
Test Events	:	5 pulses (positive & negative) for each polarity

13.2 Block Diagram of EUT Test Setup

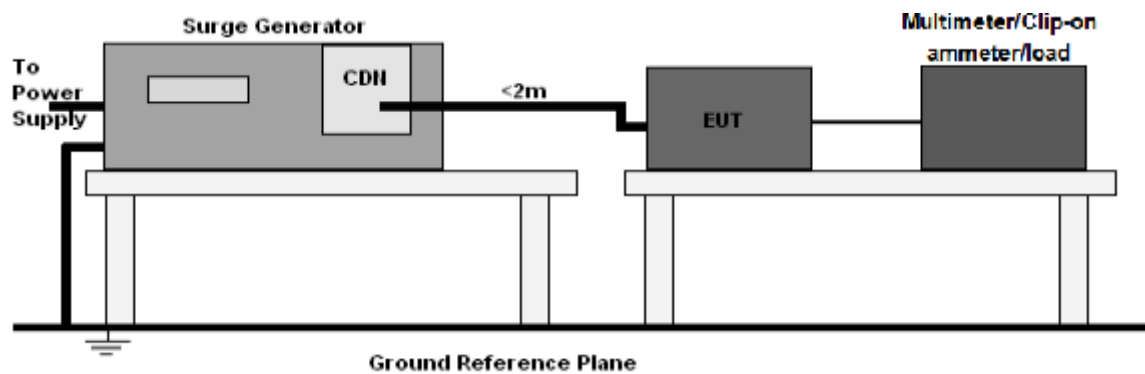

13.3 Test Procedure

- The surge is to be applied to the Product power supply terminals via the capacitive coupling network. Decoupling networks are required in order to avoid possible adverse effects on equipment not under test that may be powered by the same lines, and to provide sufficient decoupling impedance to the surge wave.
- The power cord between the Product and the coupling/decoupling networks shall be 2 meters in length (or shorter). Interconnection line between the Product and the coupling/decoupling networks shall be 2 meters in length (or shorter).

13.4 Test Result

Temperature:	26°C	Relative Humidity:	54%
Pressure:	101KPa	Test Mode:	Working 1/Working 2
Test Voltage :	AC 230V/50Hz		

Coupling Line	Voltage(kV)	Phase Angle	Required Level	Performance Criterion
L + N	+ 1.0	90°	C	A
	- 1.0	270°		

14. Continuous Induced RF Disturbances (CS)

14.1 Test Specification

Test Port	: input ac/dc. power port
Step Size	: 1%
Modulation	: 1kHz, 80% AM
Dwell Time	: 1 second

14.2 Block Diagram of EUT Test Setup

For input ac/ac. power port:

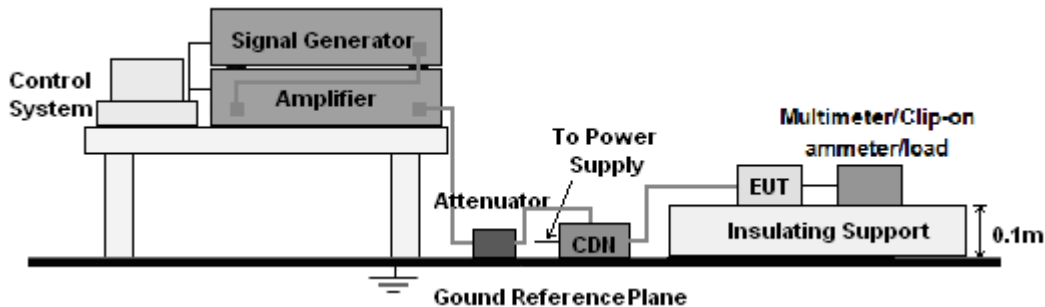

14.3 Test Procedure

For input ac/dc. power port:

- The Product and support units were located at a ground reference plane with the interposition of a 0.1 m thickness insulating support and the CDN was located on GRP directly.
- The frequency range is swept from 150 kHz to 10MHz, 10MHz to 30MHz, 30MHz to 80MHz with the signal 80% amplitude modulated with a 1 kHz sine wave, and the step size was 1% of fundamental.
- The dwell time at each frequency shall be not less than the time necessary for the Product to be able to respond.

14.4 Test Result

Temperature:	26°C	Relative Humidity:	54%
Pressure:	101KPa	Test Mode:	Working 1/Working 2
Test Voltage :	AC 230V/50Hz		

Inject Line	Frequency(MHz)	Voltage Level(V r.m.s.)	Required Level	Performance Criterion
a.c. port	0.15 - 10	3	A	A
	10 to 30	3 to 1	A	A
	30 to 80	1	A	A

15. Voltage Dips And Interruptions (DIPS)

15.1 Test Specification

Test Port	: input ac. power port
Phase Angle	: 0°, 180°
Test cycle	: 3 times

15.2 Block Diagram of EUT Test Setup

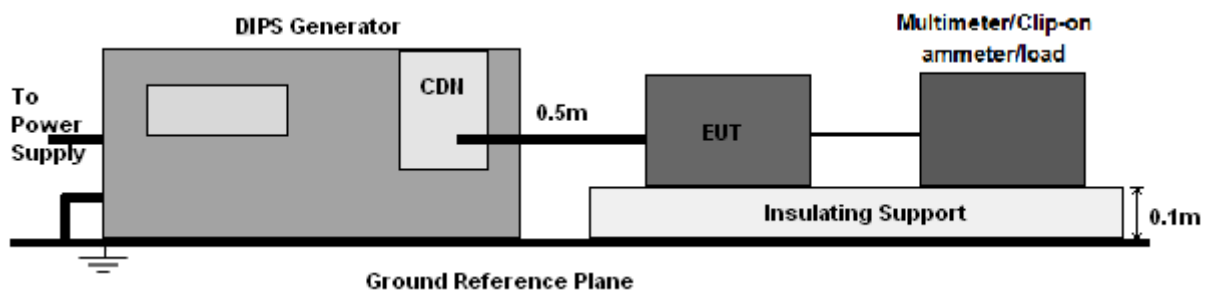

15.3 Test Procedure

- The Product and support units were located on a non-conductive table above ground floor.
- Set the parameter of tests and then perform the test software of test simulator.
- Conditions changes to occur at 0 degree crossover point of the voltage waveform.

15.4 Test Result

Temperature:	26°C	Relative Humidity:	54%
Pressure:	101KPa	Test Mode:	Working 1/Working 2
Test Voltage :	AC 230V/50Hz		

Test Level% U_T	Voltage dips in % U_T	Duration (ms)	Required Level	Performance Criterion
< 5	≥95	10	B	A
70	30	500	B	A
Voltage Interruptions:				
< 5	≥95	5000	C	C*

Note*: During the test, the product disconnects the charging connection, and the charging connection will be restored automatically after the interference end.

16. EUT Photographs

EUT Photo 1



EUT Photo 2



EUT Photo 3

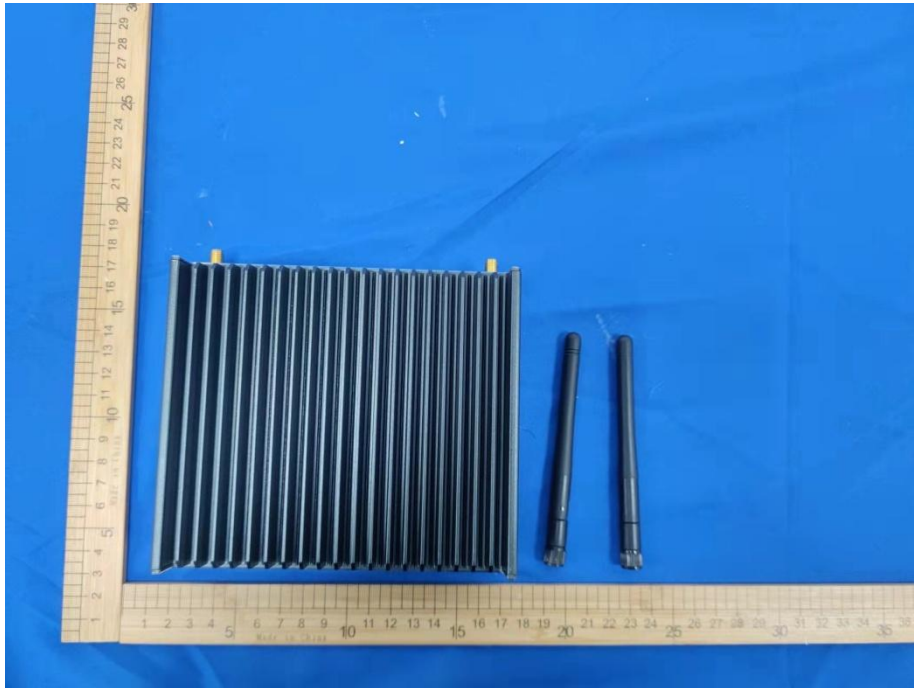

EUT Photo 4

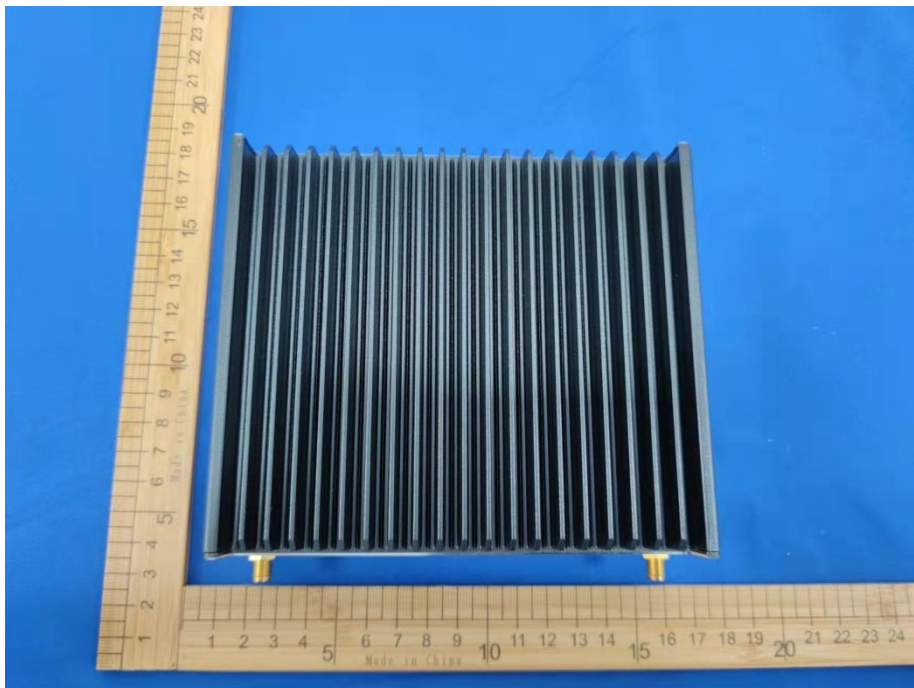

EUT Photo 5

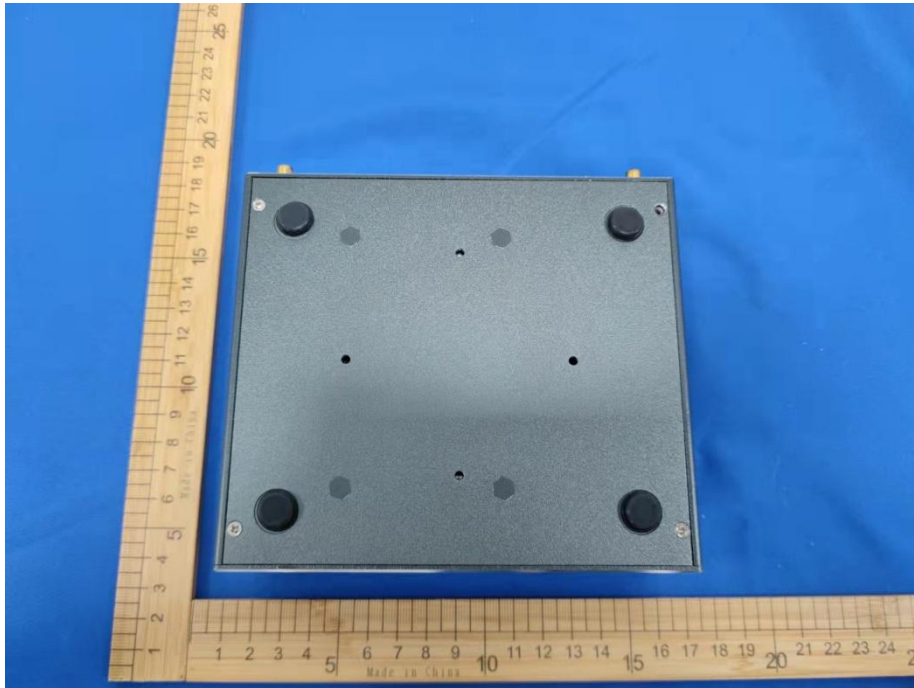

EUT Photo 6



EUT Photo 7



EUT Photo 8

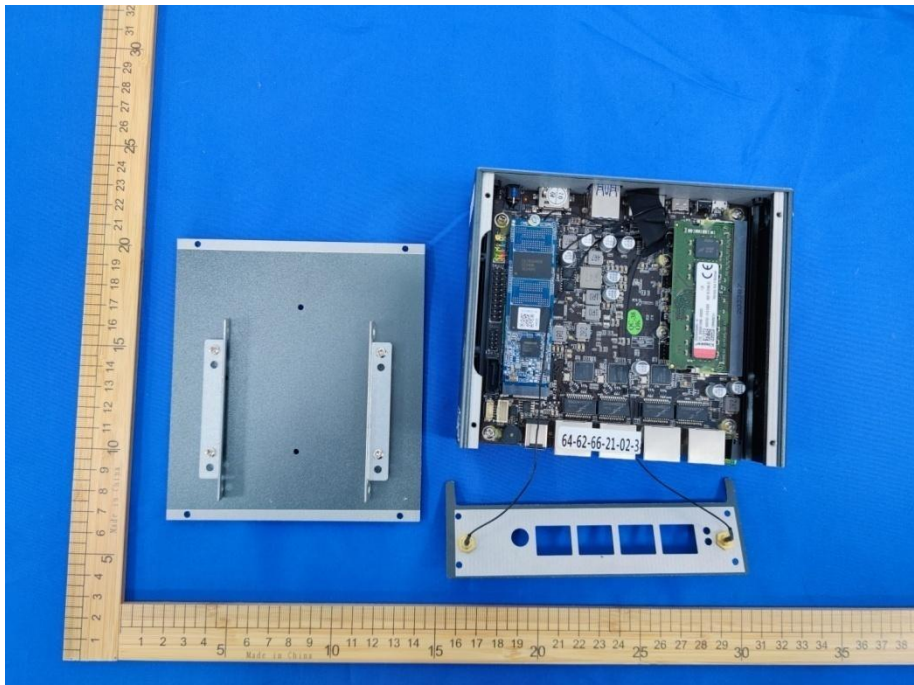

EUT Photo 9

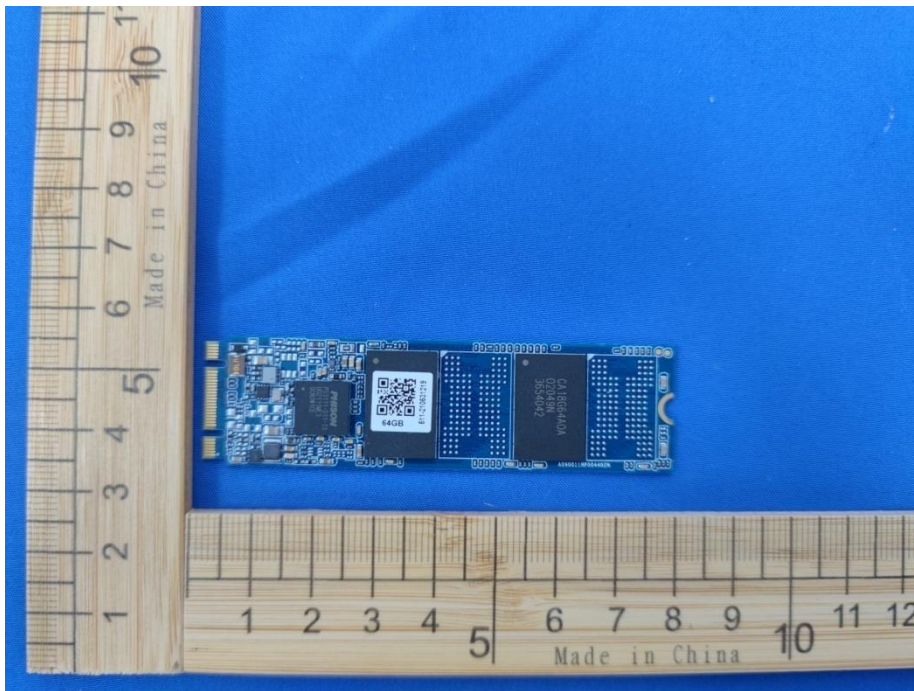

EUT Photo 10

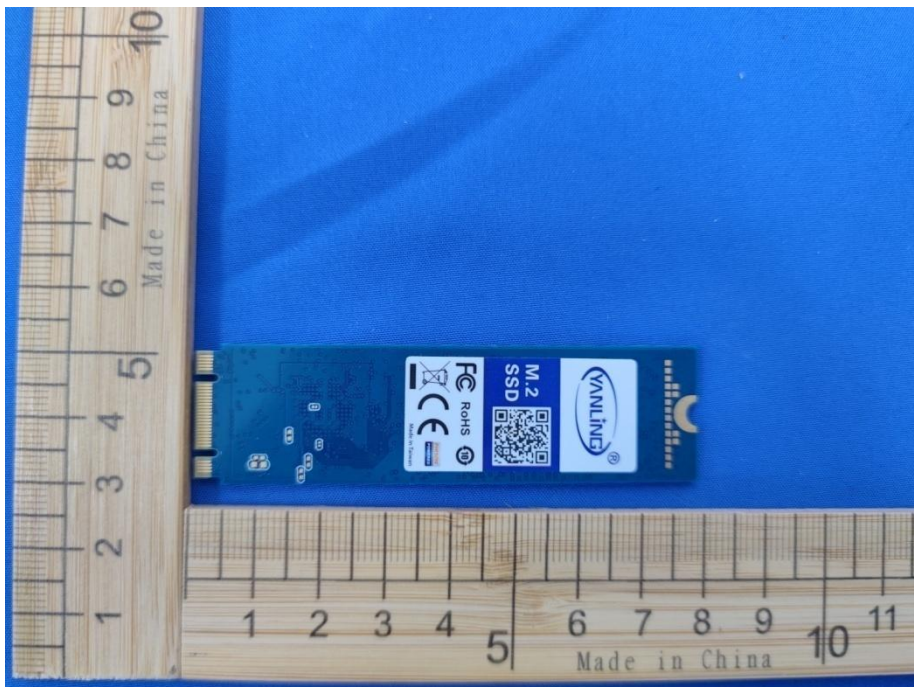

EUT Photo 11

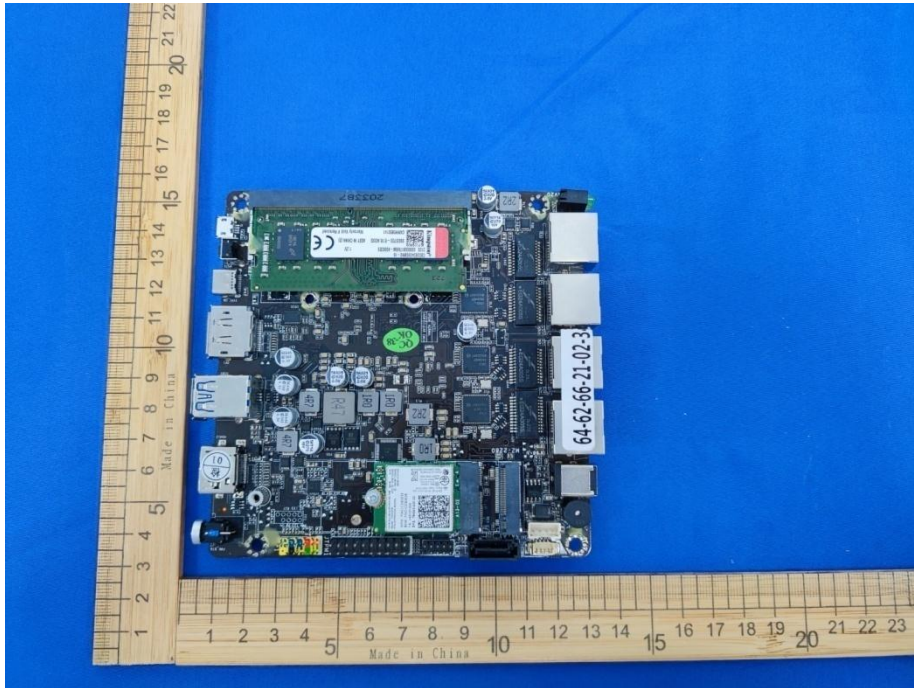

EUT Photo 12



EUT Photo 13

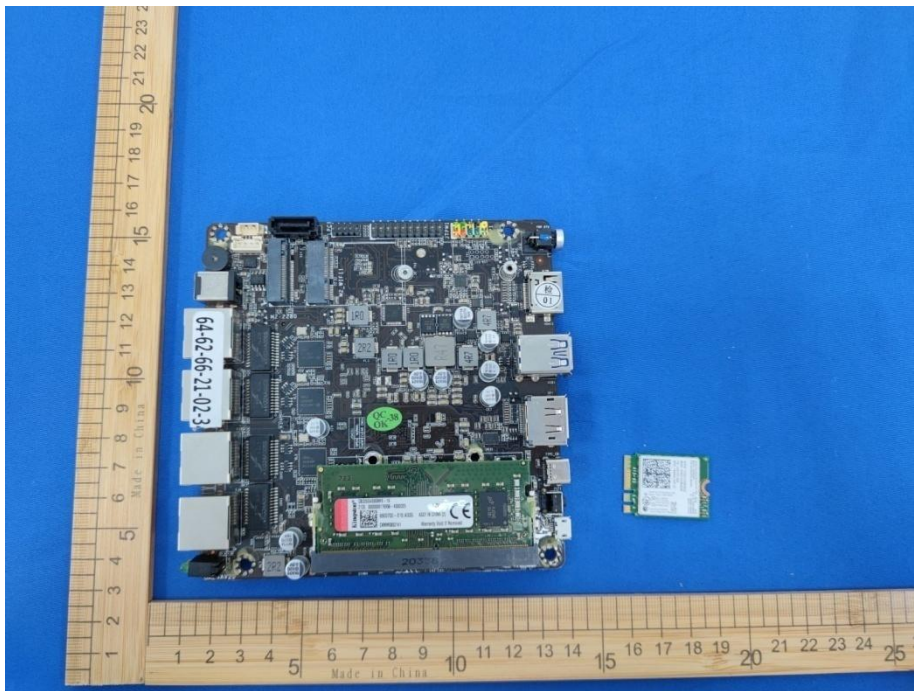

EUT Photo 14



EUT Photo 15

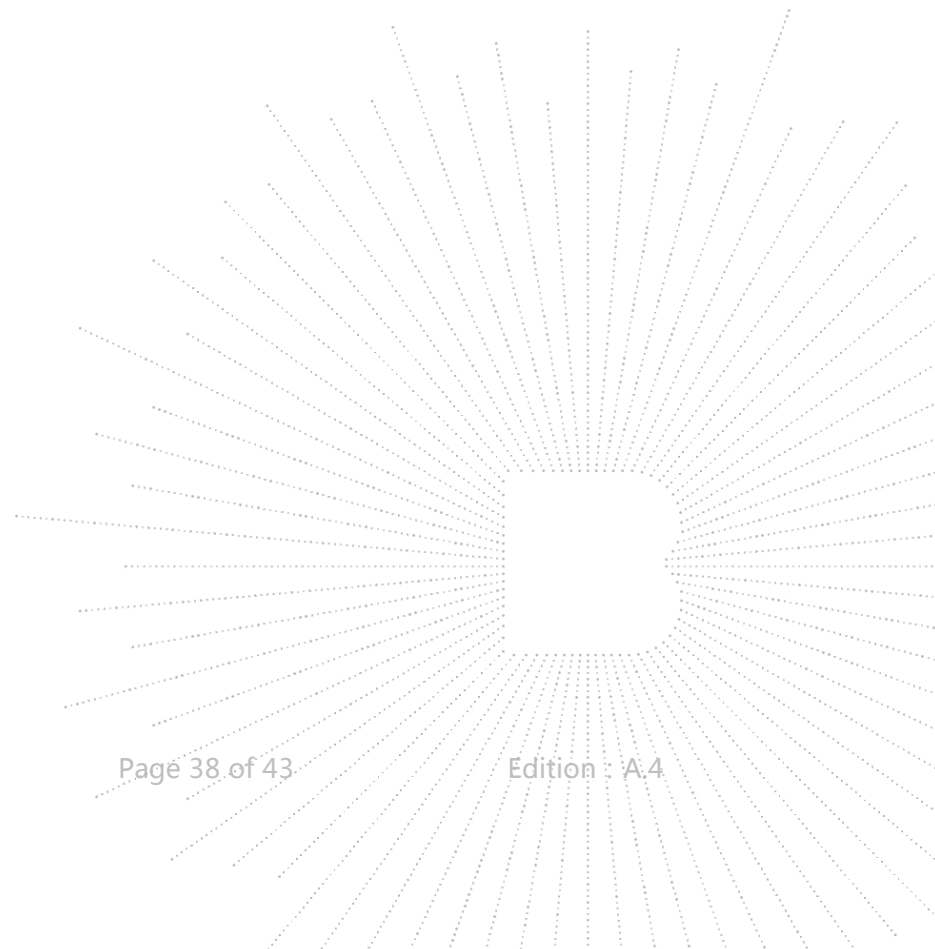
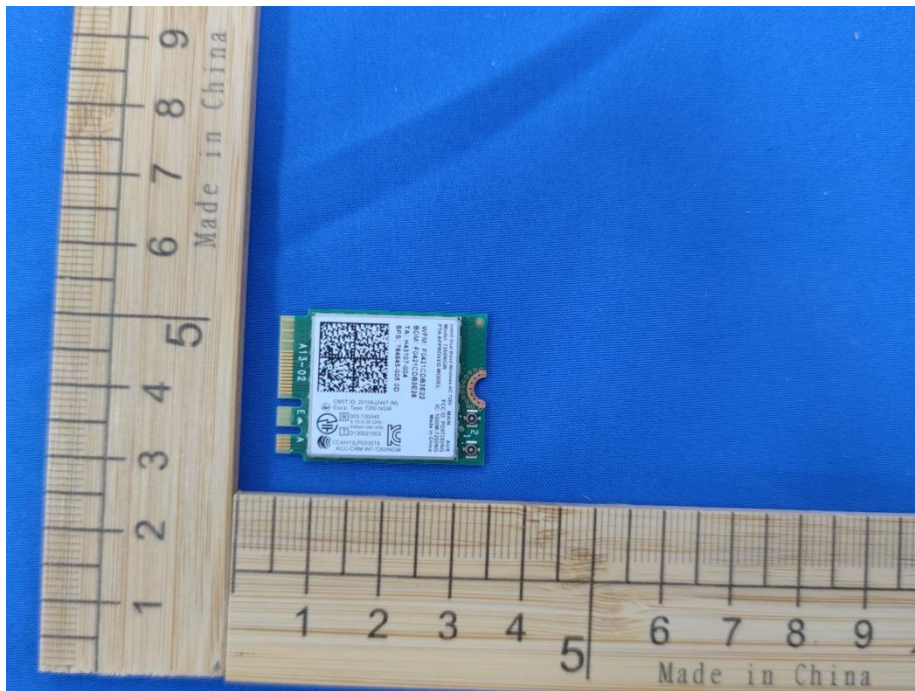

17. EUT Test Setup Photographs

Conducted emissions



TELE



Radiated emissions

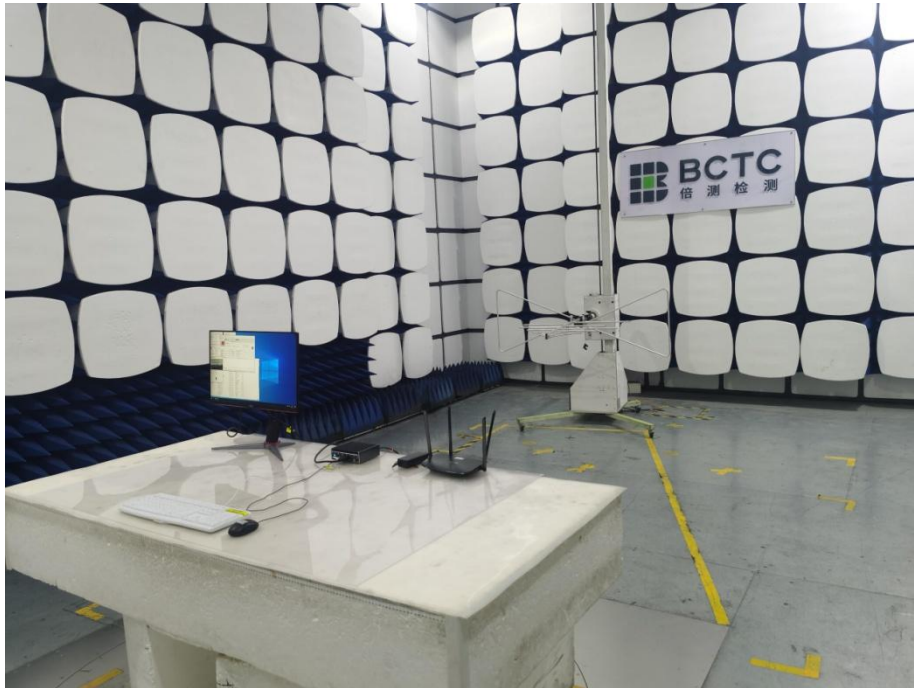

F



ESD

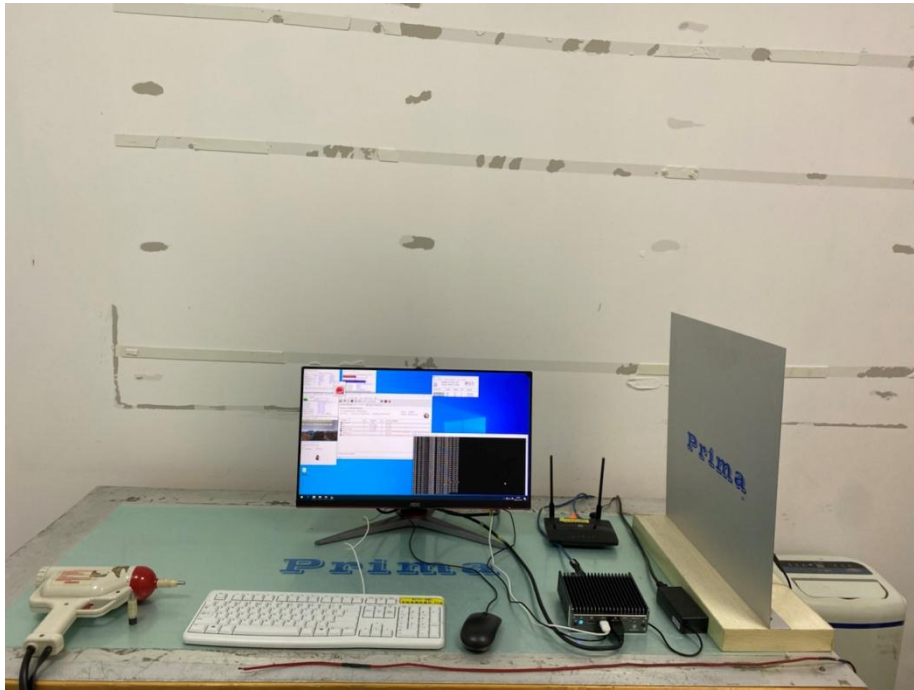

RS

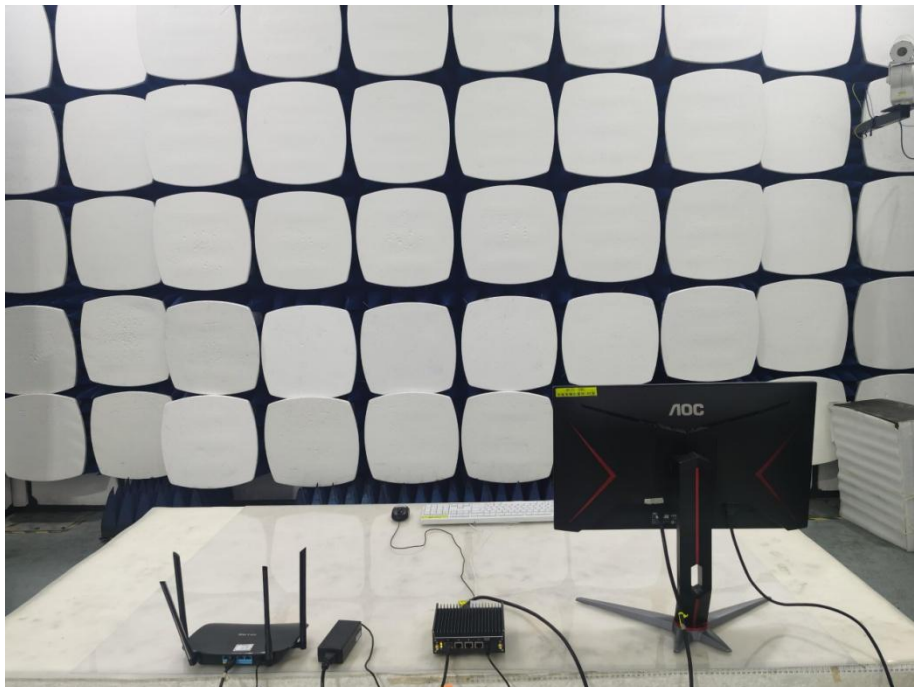

EFT& Dips & Surge



CS

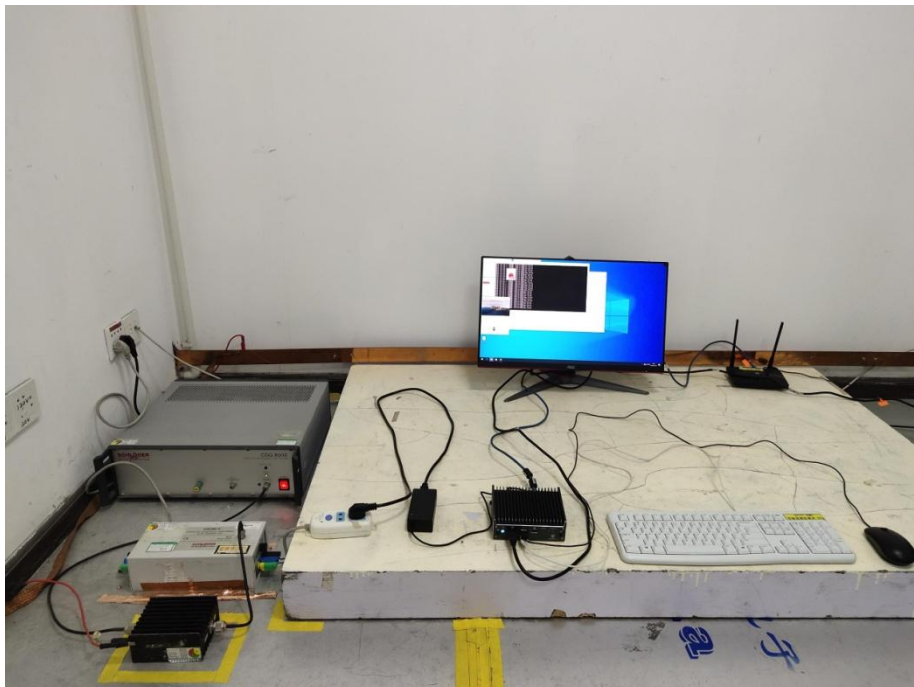

STATEMENT

- 1.The equipment lists are traceable to the national reference standards.
- 2.The test report can not be partially copied unless prior written approval is issued from our lab.
- 3.The test report is invalid without stamp of laboratory.
- 4.The test report is invalid without signature of person(s) testing and authorizing.
- 5.The test process and test result is only related to the Unit Under Test.
- 6.The quality system of our laboratory is in accordance with ISO/IEC17025.
- 7.If there is any objection to report, the client should inform issuing laboratory within 15 days from the date of receiving test report.

Address:

1-2/F., Building B, Pengzhou Industrial Park, No.158, Fuyuan 1st Road, Tangwei, Fuhai Subdistrict, Bao'an District, Shenzhen, Guangdong, China

TEL : 400-788-9558

P.C.: 518103

FAX : 0755-33229357

Website : <http://www.chnbctc.com>

E-Mail : bctc@bctc-lab.com.cn

***** END *****